

HOME E5



Installation Manual

Issue: 1.1

Date: Aug 2023

Document Link:



Installation Manual

The information included in this manual is accurate at the time of publication. However, this manual is subject to change without prior notice. In addition, the illustrations in this manual are meant only to help explain system configuration concepts and installation instructions.

Please note the images shown are for illustration purposes only.

Content

01 General Information	1
1.1 Introduction	1
1.2 Safety precautions	1
1.3 Emergency actions	1
1.4 Declaration	1
1.5 Warning labels	1
02 Product Introduction	2
2.1 Overview	2
2.2 Product specifications	3
2.3 Part list	4
03 Installation	5
3.1 Prerequisites	5
3.2 Mechanical requirements	5
3.3 Unboxing the carton	6
3.4 Installation	6
3.5 Connect the E5 to an inverter	9
04 Operating Instructions	10
4.1 Power switch and connection panel	10
4.2 Communication terminals	10
4.3 Power On/Off procedures	11
4.4 Status LED panel	11
05 Others	12
5.1 Certifications	12
5.2 System maintenance	12
5.3 Transportation and storage	12
5.4 Warranty	12
5.5 Uninstallation	13
Appendix 1: E5 Wi-Fi setup procedures	14
Appendix 2: Deye inverter power-on / power-off procedures	19

01 General Information

1.1 Introduction

This manual provides the installation instruction of the Green Solution Inc. (referred as GS in this document) residential battery E5 (referred as E5 in this document). Please keep this manual in good condition for later reference.

If you have any questions on this manual, please contact GS:

Email: support@greensolutions.tech

1.2 Safety precautions

- It is the user's responsibility to follow the instruction of the installation.
- Avoid over-charge or connection errors, or it may cause damage to the E5.
- Before installing the E5, the grid AC inputs and PV DC inputs must be disconnected.
- All wiring and cable connections must be performed by certified technicians.
- Carefully read the labels with the warning and attention signs on the connection panel of the E5.
- Before installing the E5, consult with a licensed contractor, such as a licensed electrician, and use a trained installation expert to ensure compliance with local building and electrical codes and standards, climate conditions, safety standards and all applicable codes and ordinances.

1.3 Emergency actions

The E5 design incorporates safety features and precautions to minimize the risk of failures. However, GS cannot guarantee safety performance of the product is ever exposed to abuse, damage or negligence. When there is an emergency, power off the system. (Refer to section 4.3 for power on/off procedures).

Internal material exposure

If a user happens to be exposed to the internal materials of the battery cell due to damage on the outer casing, the following actions are recommended.

Inhalation: Leave the contaminated area immediately and seek medical attention.

Contact with eyes: Rinse eyes with running water for 15 minutes and seek medical attention immediately.

Contact with skin: Wash the affected area with soap and running water and seek immediate medical attention.

Contact with ingestion: Induce vomiting and seek medical attention immediately.

1.4 Declaration

- This manual contains important information on safety and the proper instructions to install the E5.
- All the images depicted in this manual are meant only to explain the product configuration and installation instructions.
- Read and follow all warnings and instructions before installing and operating the E5. GS will not be responsible for improper installation and operation.
- If the users have installed the product in a location that is not recommended per this manual, please contact GS customer service.
- This manual is specifically for the E5.

1.5 Warning labels



Cautions, risk of electric shock.



Keep the battery pack away from children.



Keep the battery pack away from open flame or ignition sources.



The battery pack should not be disposed of with household waste at the end of its working life.



The battery pack should be disposed of at a proper facility for recycling.



Read the manual before installing and operating the battery pack.

02 Product Introduction

2.1 Overview

- E5 is a 51.2V Lithium Iron Phosphate (LFP) battery product.
- E5 is designed for residential energy storage. It must be incorporated with an energy storage inverter for all the applications.

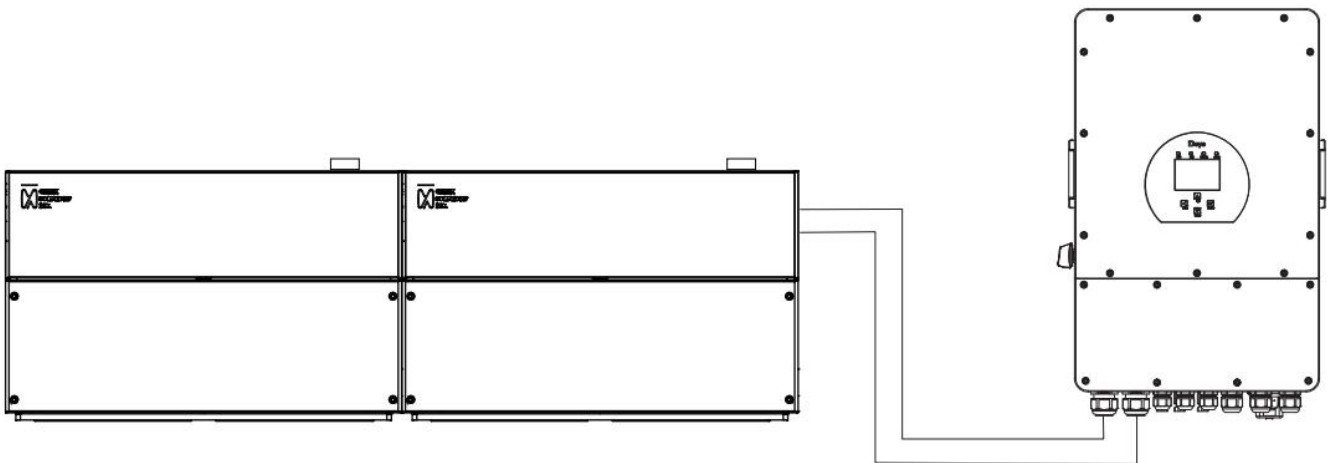

2.2 Product specifications

2.2.1 Dimensions and weight

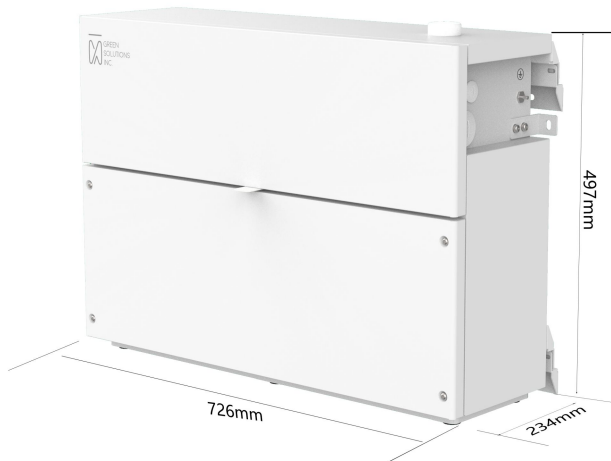

Item	Measurement
Length	726 mm/28.6 in
Width	234 mm/9.21 in
Height	497 mm/19.6 in
Weight	65 kg

2.2.2 Product specifications



Item	Specifications
Nominal voltage	51.2 V
Voltage range	40-58.2 V
Nominal capacity	100.0 Ah
Nominal/Usable energy	5.1/4.9 kWh
Max. continuous charge/discharge power	5 kW
Peak power	6 kW (3 s)
Peak current	120 A (3 s)
Max. continuous charge/discharge current	100 A
Depth of discharge	95%
Charge/discharge efficiency	≥98%
Design lifetime	10 years
Ingress rating	IP65
Communication protocol	CAN
Cooling	Passive cooling

2.2.3 Operating conditions

Item	Specifications
Operating temperature	-20°C~55°C (-4~131°F)
Optimal operating temperature	15°C~35°C (59~95°F)
Storage temperature	-20°C~45°C (-4~113°F)
Humidity	5~90%
Altitude	3000 m/9843 ft

2.3 Part list

2.3.1 Parts included in the package

 <p>E5 x1 Part 1</p>	 <p>Mounting bracket x1 Used in 3.4.2 Part 2</p>	 <p>SEMS screws x2 Used in 3.4.4 Part 3</p>	 <p>Floor mounting bracket x2 Used in 3.4.5 Part 4</p>
 <p>Floor mounting bracket screws x4 Used in 3.4.5 Part 5</p>	 <p>Ground connection nuts x1, ring terminal x1 Used in 3.4.6 Part 6</p>	 <p>2 m Power cables red x1, black x1 Used in 3.5 Part 7</p>	 <p>3 m Communication cable x1 Used in 3.5 Part 8</p>
 <p>Power cable terminal x4 Reserved Part 9</p>	 <p>Inverter communication terminal x1 Reserved Part 10</p>	 <p>E5 communication terminal x1 Reserved Part 11</p>	 <p>User manual x1 Part 12</p>

2.3.2 Cable specifications

Power cable specifications (Part 7 in section 2.3.1)

Item	Specifications
Cross-section area	25 mm ²
Diameter	11 mm
Ring size	8.5 mm
Cable length	2 m

Communication cable specifications (Part 8 in section 2.3.1)

Item	Specifications
Inverter terminal	8 cores/CAT 5e
Cable length	3 m

03 Installation

3.1 Prerequisites

3.1.1 Make sure the installation location satisfies the following conditions.

- E5 is certified for IP65 and can be installed indoors as well as outdoors. If installed outdoors, do not allow E5 to be exposed to direct sunlight, rain and snow.
- The installation location should have good ventilation.

3.1.2 Qualified installers

The tasks and procedures described herein is intended for use by skilled staff only. A skilled staff is defined as a trained and qualified electrician or installer who has all of the following skills and experience:

- Knowledge of the dangers and risks associated with installing and using electrical devices and acceptable mitigation methods.
- Knowledge of the installation of electrical devices.
- Knowledge of and adherence to this manual and all safety precautions.
- Licensed electrical contractor.

3.1.3 Warning

The optimal operating temperature range is 15°C/59°F to 30°C/86°F. If the ambient temperature exceeds the allowed operating range, E5 will be powered off automatically to protect the product from damage. Frequent exposure to extreme temperatures can result in a degradation in the product lifetime.

3.2 Mechanical requirements

3.2.1 Tools

 <p>Screwdriver 6 mm (0.23 in)</p>	 <p>Marker or pencil</p>	 <p>Hammer</p>	 <p>RJ45 Cable clamp</p>
 <p>Impact screwdriver 10 mm (0.39 in)</p>	 <p>Tap Measure 5 m (16.4 ft)</p>	 <p>Laser Leveler</p>	 <p>Socket Wrench</p>

Attention:

Use appropriate insulated tools to avoid electric shock. If insulated tools are not available, use non-conductive tape to cover the metal surface.

3.3 Unboxing the carton

3.3.1 Carton

The E5 packaging carton is made from cardboard paper.

- Set the carton on a stable platform.



3.3.2 Open the carton

Open the carton and remove the top cover by pulling it upwards.

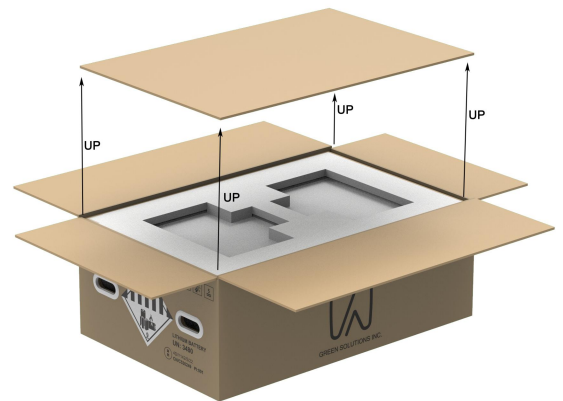

Take out the parts in the order from 1 to 5 as illustrated in the diagram above.

Perform the following checks:

- Ensure the parts listed in section 2.3.1. are available.
- Ensure there is no observable damage on the E5.

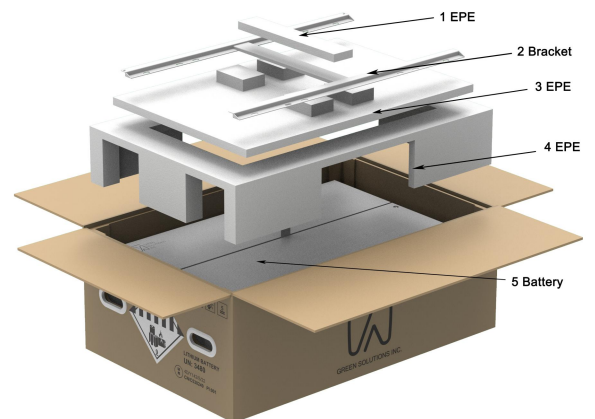

3.4 Installation

3.4.1 Installation location

- The E5 can be installed both indoor and outdoor (for outdoor installation, please refer to the following diagram for guidance). Do not expose the E5 to direct sunlight, rain and snow.
- The E5 can be mounted on a vertical wall or on the ground

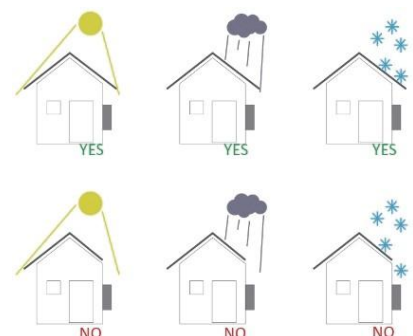

3.4.2 Clearance

The clearances shown in the diagram below are required for the E5 installation.

The E5 should be installed <1 meter from the ground to avoid damages in case of dropping. Ensure the E5 is installed in an environment with good ventilation.

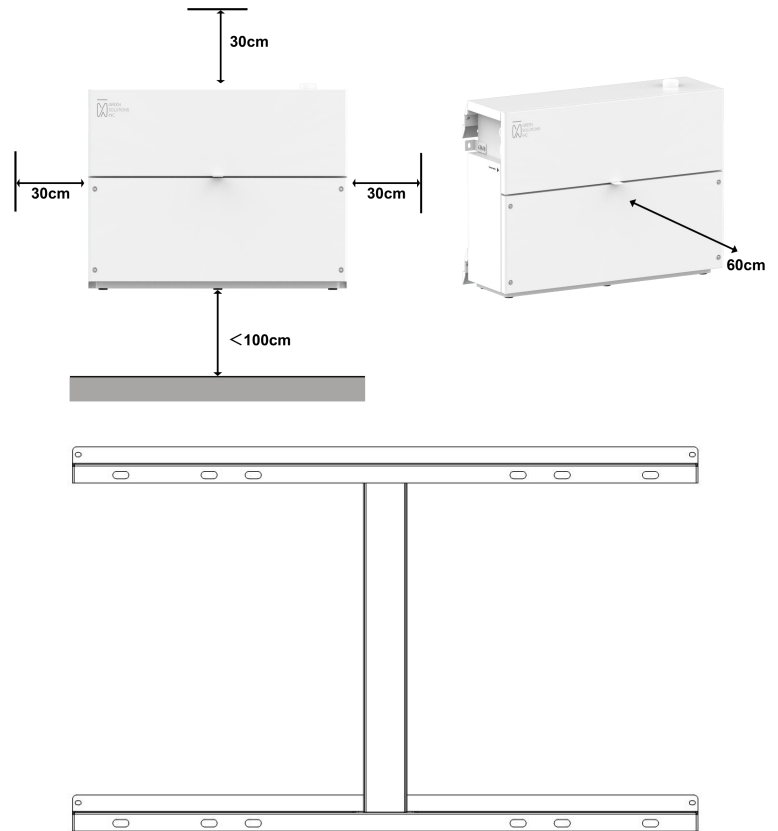

Please see the wall-mounting bracket on the left. Always secure to wall studs for proper support.

3.4.3 Installing the wall-mounting bracket

- Mark the drill locations on the wall, then drill the holes with size: 10 mm*100 mm.
- Screw in the M8*80 mm or 3.14 inches concrete anchors. For concrete wall, 4 to 6 anchors are recommended; for wood framed wall, 8 anchors are recommended.
- Place the mounting bracket on the wall; To ensure precision, please measure with a leveler.
- Tighten the anchors and bracket.

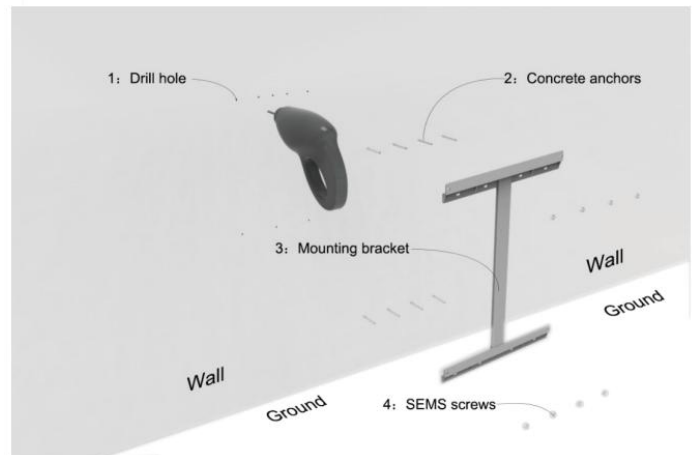

3.4.4 Mounting the E5 on the bracket

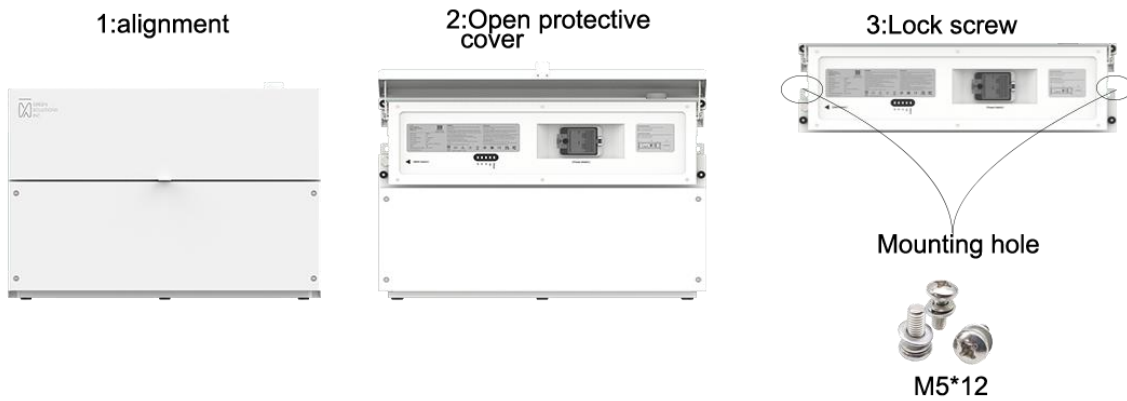

- Align the E5 to the center mounting bracket.
- Open the protection front cover.
- Drive the M5*12mm SEMS wall mount lock screws through the mounting bracket into the mounting holes and tighten them to a torque of 2.5 N.m.

3.4.5 Installing the E5 on the ground

- Move the E5 close to the wall.
- Screw the two sets of the floor mounting brackets to the both sides of the E5 with torque 4.5N.m.
- Attach the floor brackets to the wall to prevent the E5 from falling forward.

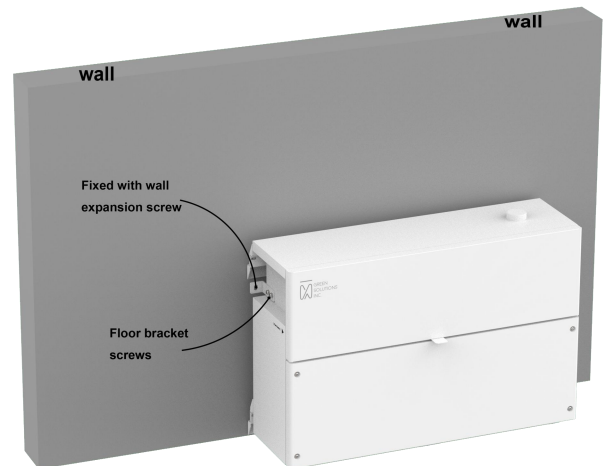

3.4.6 Grounding

- Ensure the E5 is powered off before making the grounding connection.
- Connect the grounding pole to the SC4-6 copper connection base. Make sure the connection is tight and fixed. The maximum torque is 5 Nm.
- Do not connect the grounding wire to the painted metal structure or surface, and do not twine the grounding connector.

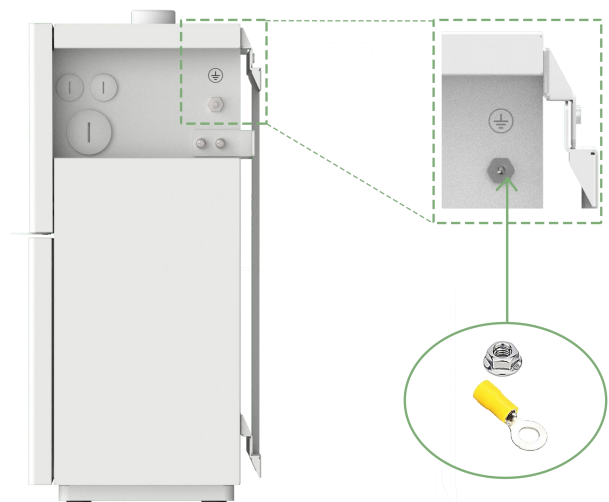

3.5 Connect the E5 to an inverter

- Open the protection cover and remove the waterproof cover with a screwdriver.

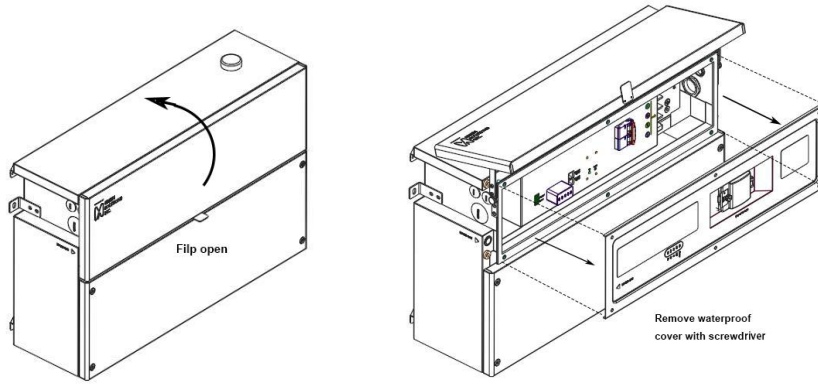

- Ensure the E5 breaker is switched to OFF position.
- Making positive (+, red) and negative (-, black) power connections to that of an inverter (refer to the diagrams below for instructions)
- Connect the communication cable (green).

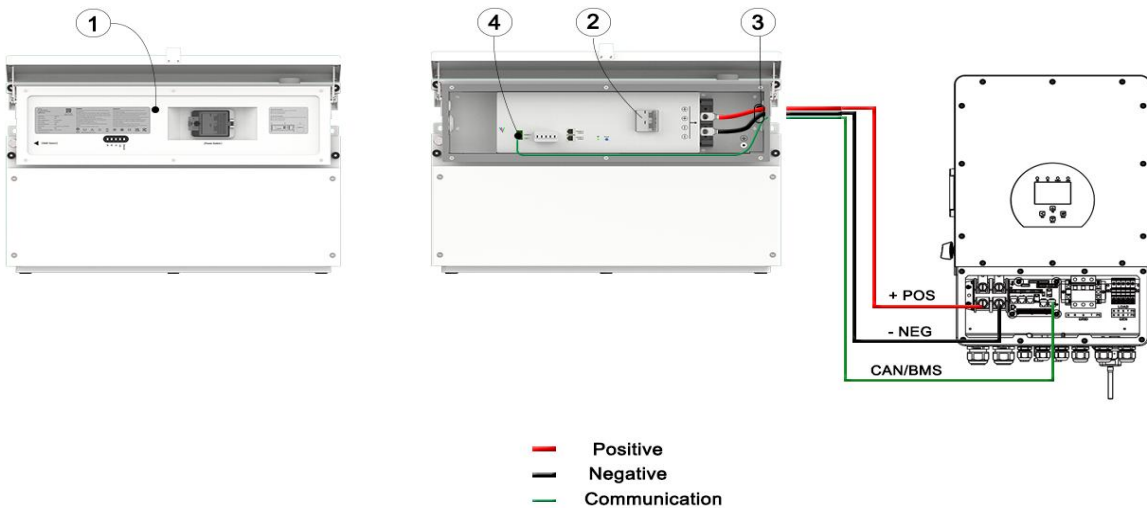

- Connection cables can exit the chassis on either left or right side, depending on the inverter location. See diagrams below for details:

Note: The power and communication cables can enter the E5 from both the left and right side.

Cable connection from the right:

Cable connection from the left:

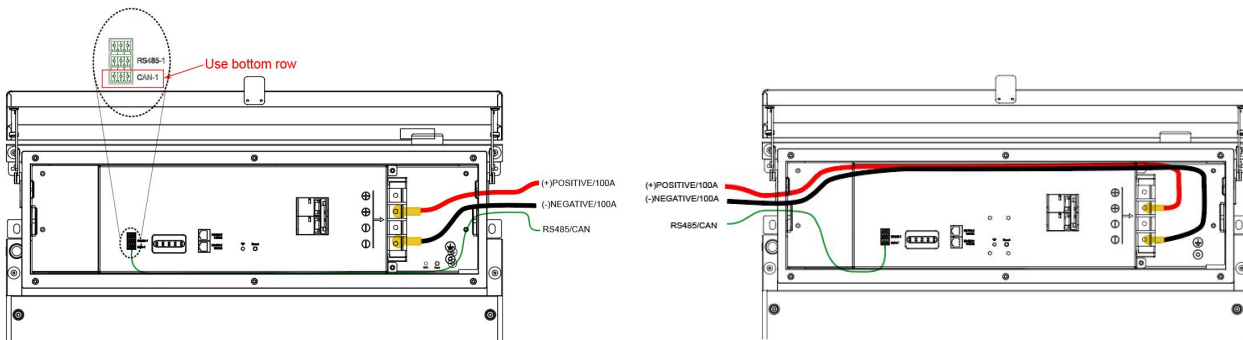

- Re-install waterproof cover and close the protective cover.

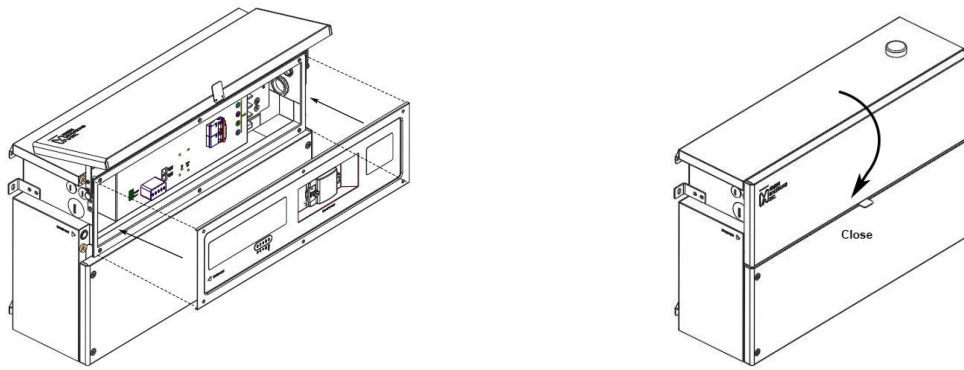

04 Operating Instructions

4.1 Power switch and connection panel

The connection panel of the E5 shown below allows the users to access to all the connection terminals of the product.

No	Items	Connector Type	Remark
①	Power terminal block	HP-T3015-4P-CL0	
②	BMS communication terminal	KF2EDGKNH-3.81*3P*3	
③	Status LED	N/A	Capacity and status indication
④	Power output breaker	B1E2P125	
⑤	RJ45 communication terminal	RJ45	BMS-PC communication or BMS-BMS communication
⑥	BMS On/Off button	LB19B	
⑦	WiFi power button & antenna	WBR1-IPEX	

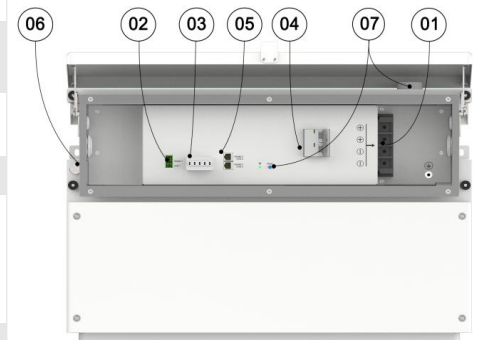

4.2 Communication terminals

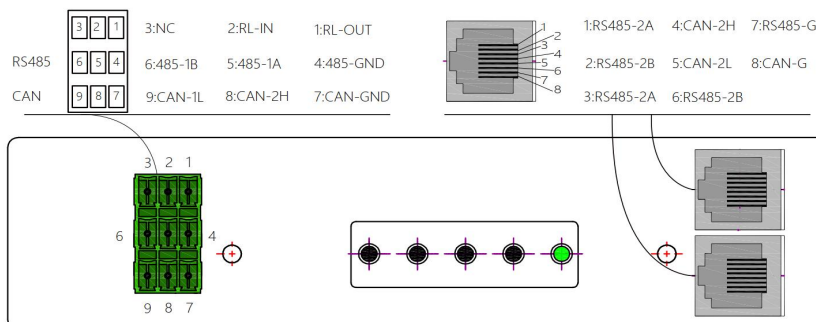

4.3 Power On/Off procedures

4.3.1. Power On procedure

- After connecting all the cables to the E5 battery, switch the breaker to ON position.
- Push the BMS switch.
- Check the LED panel on the E5 for a green status light. (It takes 1 min for the E5 to be powered up. During the initialization period, all FOUR capacity LED will blink at 3s. Once initialization completed, the capacity LED will stay solid white according to the battery capacity percentage.)

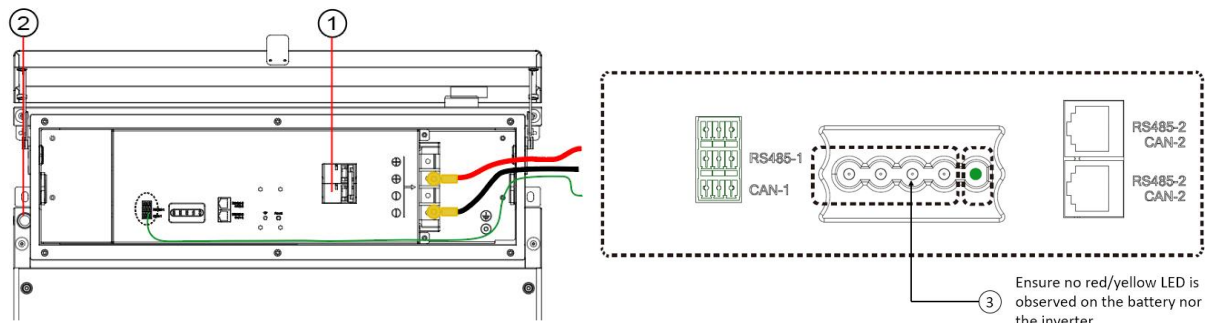

4.3.2. Power Off procedure

- Press the push button (1 in the diagram) to turn off the E5.
- Switch the breaker to OFF position.

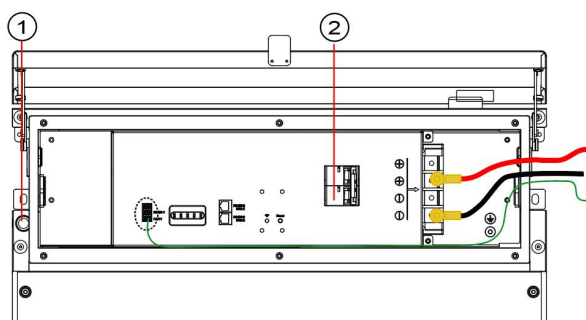

4.4 Status LED panel

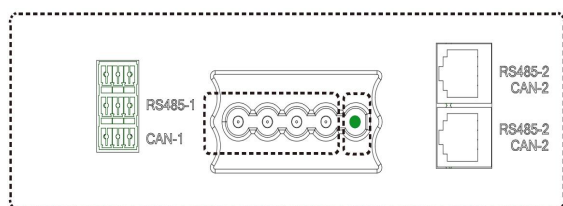

4.4.1. Capacity percentage and system status

Capacity percentage	Status Display	LED	Mode
0% ● ● ● ●	Normal	●	Blink at 1s
25% ○ ● ● ●	Alarm	●	Blink at 1s
50% ○ ○ ● ●	Protection/Failure	●	Stay On
75% ○ ○ ○ ●			
100% ○ ○ ○ ○			
LED off ● LED on ○			

Please contact GS for technical support if the alarm or the failure signal is on.

05 Others

5.1 Certifications

Item	Standard
Pack certifications	UL1973/IEC62619/CE/FCC/UKCA/MSDS
Cell certifications	UL1973/UL9540A/IEC62619 JIS8715-2/SII Crush & Nail UN38.3
Transportation certifications	UN38.3

5.2 System maintenance

The E5 must be charged at least once every three months if it is not in use. It is NOT recommended to have the E5 stayed in idle or turned off for more than three months.

Visually inspect the exterior of the unit and associated cabling for every 12 months. For any signs of damage, report these to support@greensolutions.tech.

Further maintenance should only be conducted by certified technicians following instructions from the manufacturer.

5.3 Transportation and storage

5.3.1. Transportation

- Do not drop, impact, or pierce the E5 enclosure.
- Use proper tools and protective gear to move the package. Operators should wear safety tools.

Transportation temperature	5 °C ~ 30 °C
Transportation humidity	65±20 %RH

5.3.2. Storage

- Do not expose the E5 under direct sunlight. Do not locate the E5 in a high ambient temperature environment above 55°C or expose to fire.
- Do not immerse the E5 in water or other fluid or expose to humid environment.
- Do not store the E5 inside the area with corrosive gas.

5.4 Warranty

5.4.1. Scope

GS protects this product under warranty when it is installed and used as detailed in this manual. Violating the installation procedure or using the product in any way not described in this manual immediately voids all warranties on the product.

GS does not provide warranty coverage or assume any liability for direct or indirect damages or defects that result from the following causes under section 5.4.2.

5.4.2. Limited liability

Damage to the Products resulting from any of following activities is NOT covered by this Limited Warranty

- Improper transportation or storage.
- Improper installation, wiring or handling.
- Use the E5 in inappropriate environment and conditions.
- Improper operation.

- Insufficient ventilation
- Failure to follow safety cautions and instructions.
- Unauthorized maintenance and modification.
- Inverter failure or overcurrent.
- Force majeure.
- External influences, such as unusual physical or electrical stress.
- Paired and used with incompatible inverter.

5.5 Uninstallation

- Before uninstalling the E5, please follow the procedures of section 4.3.2 to power off the system.
- All non-usable E5 must be uninstalled by certified technicians.
- Installer should read section 3, the Installation process, before uninstalling the E5.

Appendix 1: E5 Wi-Fi setup procedures

- Turn on the E5 battery.
- Locate the Wi-Fi button and press for 7 seconds until a flashing green LED is obtained, then E5 enters into a pairing mode.



- Turn on the Wi-Fi and Bluetooth on a smartphone/tablet that has connected to the home Wi-Fi.



- Search in the Apple App store or Google Play store for “Smart Life – Smart Living”. Click download and open.

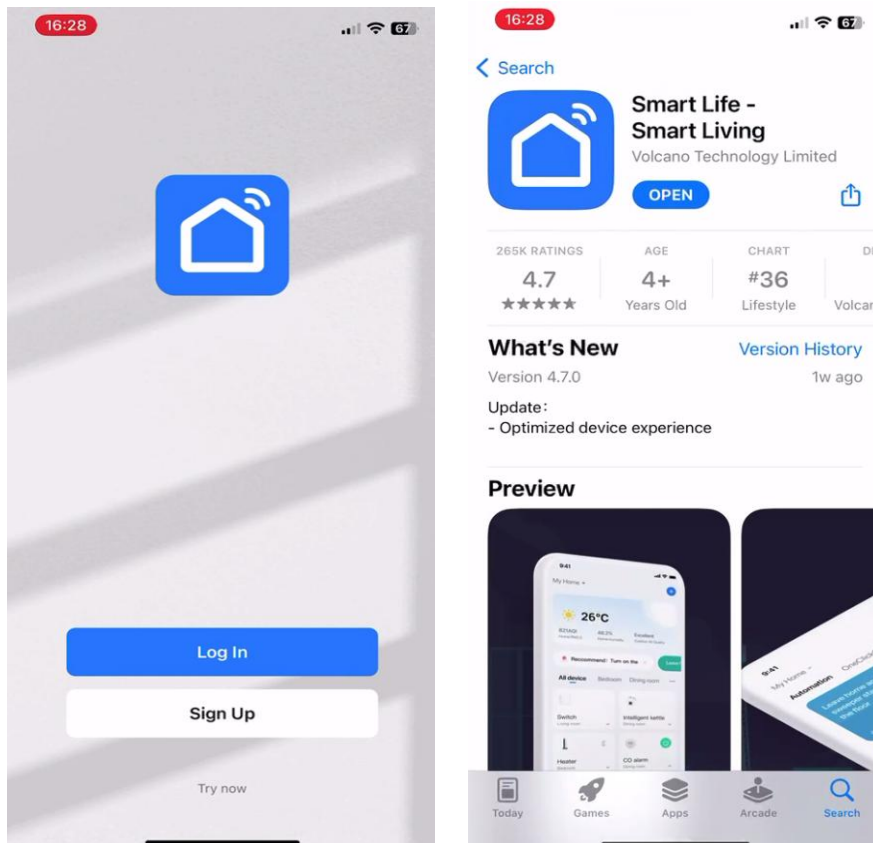

- Click “Sign up” and then register. Follow the steps to select country/region and enter email address.
- Click “Get Verification Code” A verification code will be sending to the email address. Enter the Verification Code

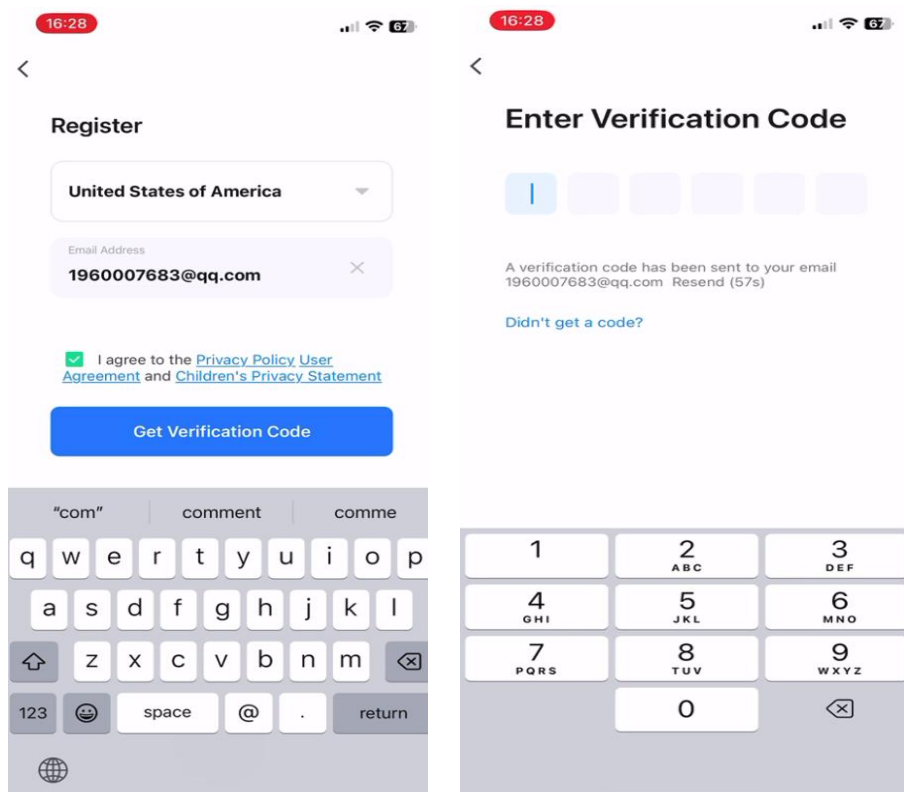

- After the verification is completed. Set and enter a password to complete the user registration.

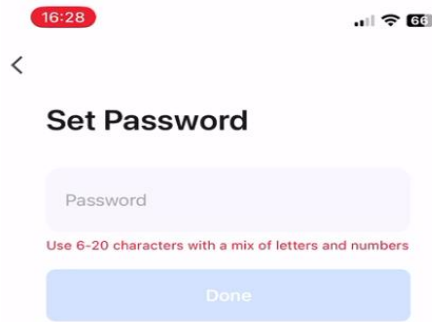

- Use the email address and password to login to the APP. Select both “Data Analysis” and “Personalization” and click “Go to App”.

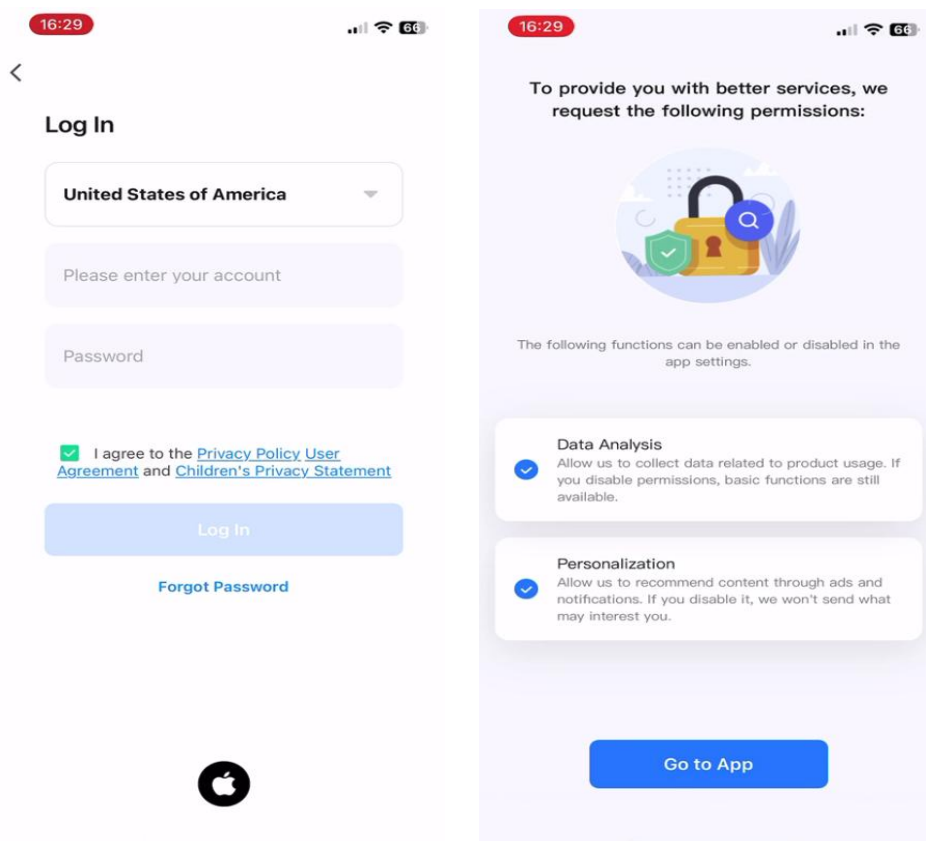

- Click “+” button on the top right corner and “Add device”, it will start search for E5. Ensure the E5 is in the pairing mode (green Wi-Fi LED blinking). When it shows “Discovering devices”, click the “Add” button.

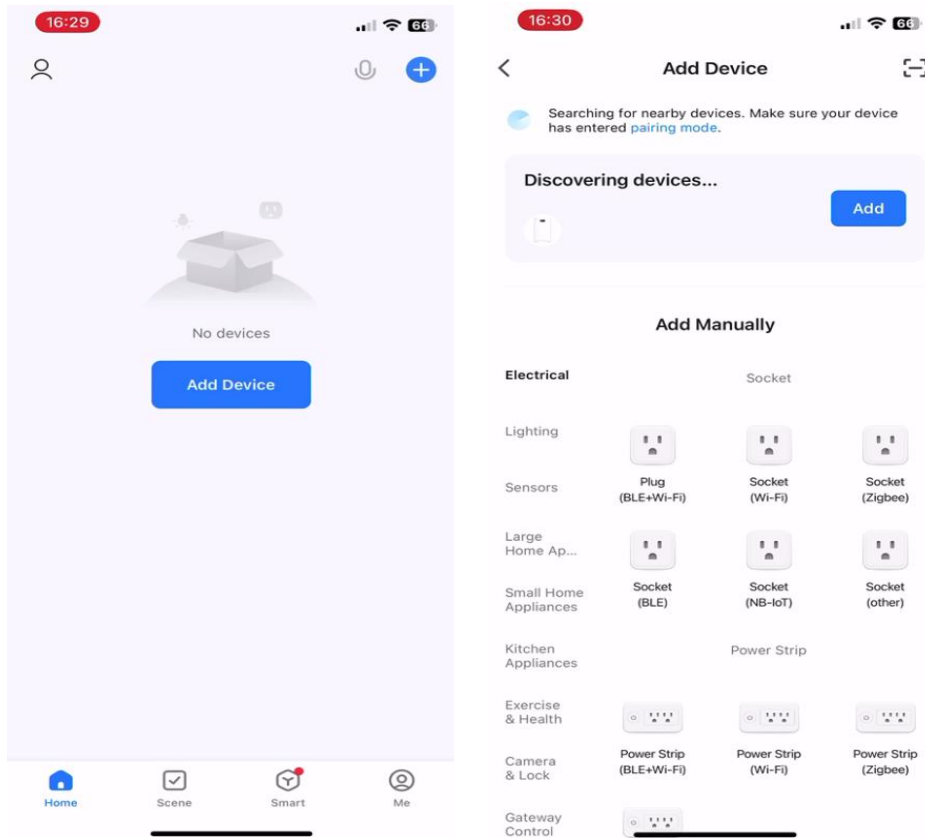

- Choose the home Wi-Fi and click “Next”. HOME E5 will show up. Wait for the installation to complete. When the pairing up is successful, the green Wi-Fi LED will stay solid on.

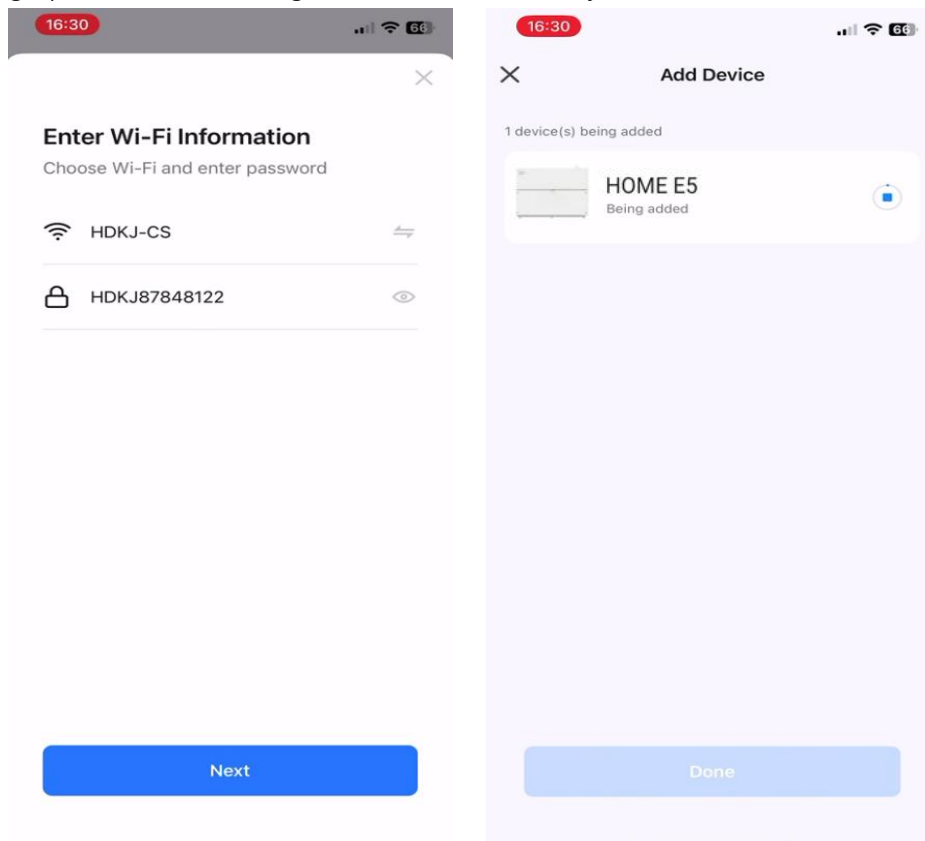

- When the installation is completed. A notice “Home E5 added successfully” will be shown. After the setup is completed, battery information can be checked from the APP interface.

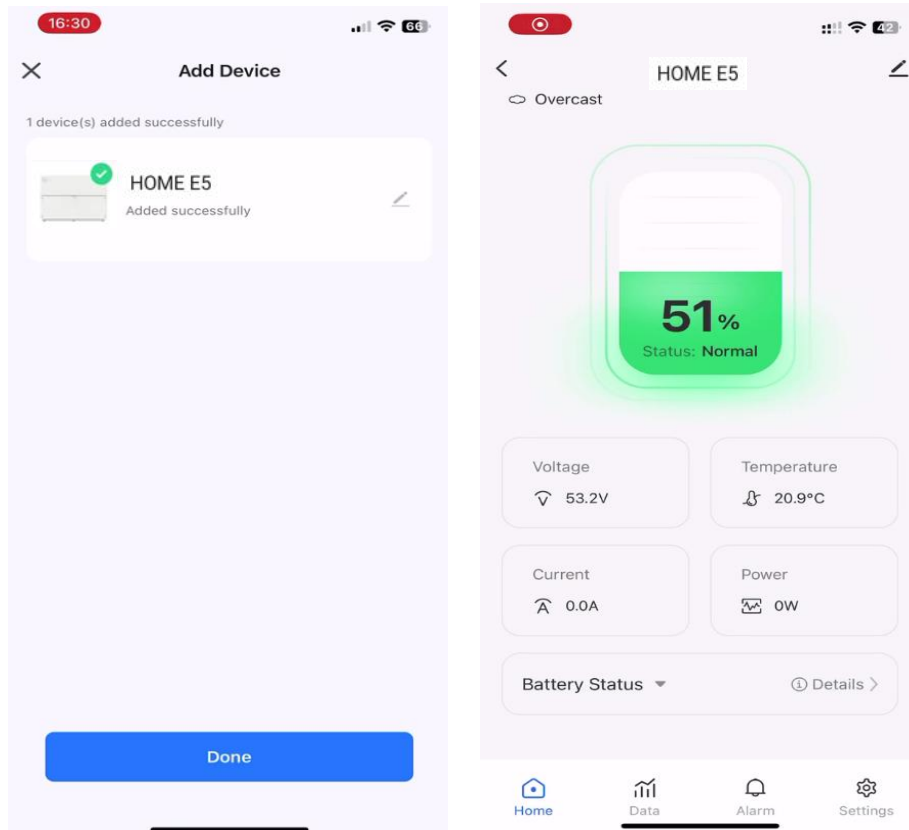

- For connecting to a second E5 battery, repeat the step 8 to 11 above.

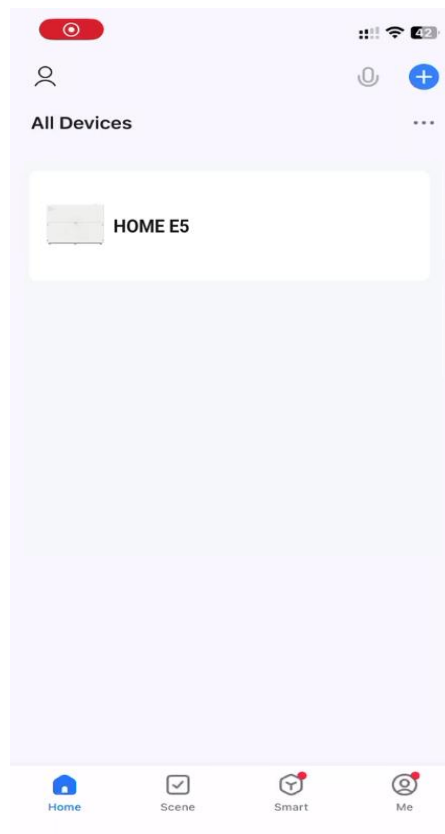

Appendix 2: Deye inverter power-on / power-off procedures

A1.1 Power-on the Deye inverter

- Unload the protective cover of the inverter.
- Connect the E5 properly by following the procedures in the E5 installation manual.
- Ensure the inverter is connected properly with grid and PV (if available).

- If there is a grid connection, turn the main grid switch (AC) to on position.

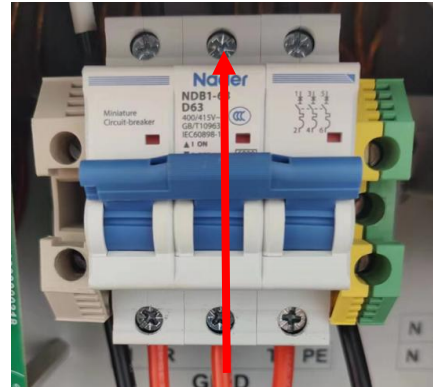

- If there is a PV connection, connect the PV by turning the DC switch to on position.



- Press ON/OFF button (located on the left side of the inverter) to turn on the inverter (Blue LED ring will light up).

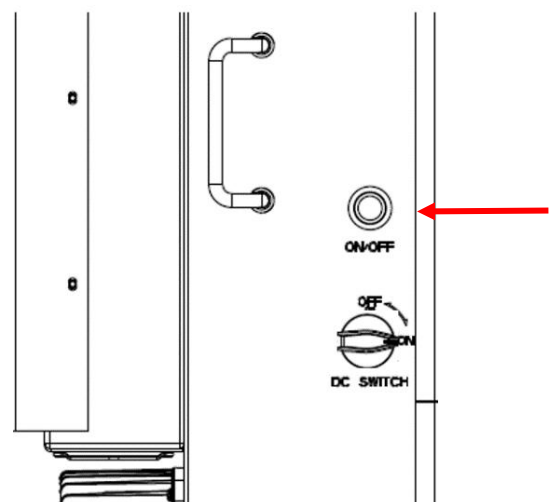

- Reload the protective cover of the inverter.
- When the inverter is not connected with a battery (but it is connected with either grid or PV) and ON/OFF button is switched off, LCD will still light up (Display will show OFF). Press the ON/OFF button and select NO battery, the system can still operate.

A1.2 Power-off the Deye inverter

- Unload the protective cover of the inverter.
- If there is a grid connection, turn the main grid switch (AC) to off position.

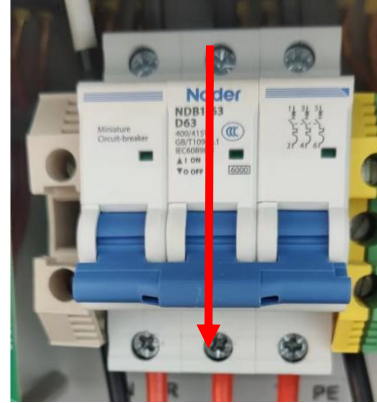

- If there is a PV connection, disconnect the PV by turning the DC switch to off position.



- Release the ON/OFF button (located on the left side of the inverter) to turn off the inverter (Blue LED will be off).

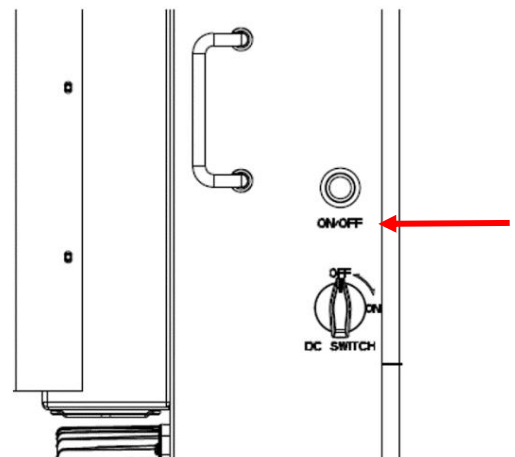

- Reload the protective cover.



www.greensolutions.co